

Suzuki Model Identification

Model Description	Horse-power	Model Variation	Shaft Length	Model Year
DT = 2-cycle DF = 4-cycle PU = Jet Drive	Examples: 9.9 40 115 250	E - Elec. Start w/Tiller Handle R - Elec. Start w/Remote Control C - Oil Injection G - Counter Rotation N - High Thrust Propeller T - Power Tilt & Trim w/Elec. Start w/Remote Control H - Power Tilt & Trim w/Elec. Start w/Tiller Handle SF - Super Four SS - Super Six M - Manual Start w/Tiller Handle V - Comlink Voice Caution System	S = 15" L = 20" X = 25"	D = 1983 E = 1984 F = 1985 G = 1986 H = 1987 J = 1988 K = 1989 L = 1990 M = 1991 N = 1992 P = 1993 R = 1994 S = 1995 T = 1996 V = 1997 W = 1998 X = 1999 Y = 2000 K1 = 2001 K2 = 2002 K3 = 2003 K4 = 2004

EXAMPLE: DT40CRSN - 2-cycle, 40 HP, Oil Injection, Elec. Start w/remote control, 15", 1992 Model Year

OUTBOARD

**18-5225
SPARK PLUG WIRE KIT**

Replaces:
Mercury 84-99215A26,
84-813706A26
Kit includes 25 ft. Roll of 7 MM Hypalon Ignition Wire With a Metallic Core and a Large Assortment of Three Different End Fittings to Fit Outboard Motors.



**18-5226
IGNITION WIRE
Metallic Core**

100' Spool
7mm Hypalon



PKG. OF 10



**18-5224
18-5224-9①
SPARK PLUG WIRE TERMINAL**

Replaces: Mercury 20121
OMC 510364

PKG. OF 10



**18-5750
18-5750-9①
UNIVERSAL SPARK PLUG BOOTS**

Supplied complete w/Terminal Connector
Replaces: OMC 581027, 580339



**18-5752
UNIVERSAL
SPARK PLUG BOOTS
8mm**



**18-6416
OUTBOARD STARTER**

Replaces: Suzuki 31100-94610
Fits: 115, 140 H.P. (9 Tooth) (1984-UP)



**18-6428
OUTBOARD STARTER**

Replaces: Suzuki 31100-95313
Fits: 50/60H.P. (1984-85), 75/85H.P. (1984-87)

① Priced per Package

 <p>18-6417 OUTBOARD STARTER Replaces: Suzuki 31100-92E00 Fits: 150, 200, 225 H.P. (1985-UP)</p>	 <p>18-6429 OUTBOARD STARTER Replaces: Suzuki 31100-94702 Fits: DT 55/65 (1985-88)</p>							
 <p>18-6414 OUTBOARD STARTER Replaces: Suzuki 31100-95600 Fits: 75 HP</p>	 <p>18-6419 OUTBOARD STARTER Replaces: Suzuki/Nissan 31100-89J01 Fits: Suzuki 40HP, Nissan 30HP (9 tooth)</p>							
<p>NEW</p>  <p>18-56008 BRUSH HOLDER ASSY Replaces: 31173-95310 Fits:90-100, 150-225 HP 2 Stroke Use with 18-6414 Starter</p>	<p>NEW</p>  <p>18-56009 BRUSH HOLDER ASSY Replaces: 31173-99E00 Fits:115-140 HP 2 Stroke Use with 18-6416 Starter</p>	 <p>18-9802 TIMING LIGHT Self-powered accurate up to 10,000 RPM's</p>						
 <p>18-6785 TILT/TRIM MOTOR Replaces: 38100-87E10-0ED, 38100-87000-0IT, 38100-87E20-0ED For: V-4 & V-6 1986-1990 V-6/3 wire hook-up 3 bolt flange</p>	 <p>18-6786 TILT/TRIM MOTOR Replaces: 38100-87D10-0ED, 38100-87D10-35J, 38100-87D10-0IT For: V4 & V6 1990-up 3 Bolt flange 2 wire connection</p>	<p>NEW</p>  <p>18-7773 CARB KIT Replaces: 13910-89J01 Fits:DF 25/30 (All Years)</p>						
 <p>18-7752 CARB KIT Replaces: 13910-87D00</p>	 <p>18-7753 CARB KIT Replaces: 13910-94400</p>	 <p>18-7754 CARB KIT Replaces: 13910-94701</p>	 <p>18-7755 CARB KIT Replaces: 13910-95D00</p>					
Carburetor Kit Application								
HP/Model	Year	Sierra#	HP/Model	Year	Sierra#	HP/Model	Year	Sierra#
DT25C	1989-98	18-7755	DT65	1985-97	18-7753	DT100	1989-98	18-7752
DT30C	1988-97	18-7755	DT75	1985-97	18-7754	DT115	1986-98	18-7754
DT40C	1984-98	18-7753	DT85	1985-98	18-7753	DT140	1986-98	18-7753
DT55	1985-97	18-7754	DT90	1989-97	18-7752	V-6	ALL	18-7752

OUTBOARD

SUZUKI

Fuel System



OUTBOARD

8' LENGTH COMPLETE FUEL LINE ASSEMBLIES				
5/16"	18-8018	SILVERADO 2000 Premium	OE#65700-95513	
18-8078 FUEL CONNECTOR	18-8079 FUEL CONNECTOR	18-8004 PRIMER BULB	18-8079 FUEL CONNECTOR	
FUEL LINE ASSEMBLY COMPONENTS				
8' LENGTH COMPLETE FUEL LINE ASSEMBLIES				
5/16"	18-8019	SILVERADO 2000 Premium		
18-8071 TANK CONNECTOR	18-8062 FUEL CONNECTOR	18-8004 PRIMER BULB	18-8062 FUEL CONNECTOR	
FUEL LINE ASSEMBLY COMPONENTS				
6' LENGTH COMPLETE FUEL LINE ASSEMBLIES				
3/8"	18-8035	SILVERADO 2000 Premium	OE#65700-87J10	
18-80405 FUEL CONNECTOR	18-8005 PRIMER BULB	18-80404 FUEL CONNECTOR		
FUEL LINE ASSEMBLY COMPONENTS				
Fits: DF25-140 HP (2000-05)				
18-8004 PRIMER BULB Replaces: 174511 Large capacity bulb	18-8005 PRIMER BULB Replaces: 174512 Large capacity bulb	18-8062 FUEL CONNECTOR Replaces: 65750-98505 For use with 18-8071		

* Tanks and Engines for picture purpose only. ① Discount shop pack of 10 - Priced per package



















 <p>18-8071 FUEL CONNECTOR 1/4" NPT .432 O.D. Replaces: 99105-00192 For use with 18-8062 (Male)</p>	 <p>18-8078 TANK CONNECTOR 1/4" N.P.T .508 O.D. Replaces: 65740-95500, 99105-00193 For use with 18-8079 (Male)</p>	 <p>18-8079 FUEL CONNECTOR (Tank End) Replaces: 65750-95510 For use with 18-8078 (Female)</p>	 <p>18-8087 FUEL CONNECTOR Replaces: 65720-94411 (Metric Threads)</p>									
 <p>18-8106 FUEL CONNECTOR (Female Fitting) For: 5/16" & 3/8" I.D. hose (with 3 retaining balls) For: Suzuki below 60 HP Corrosion resistant chrome plated brass</p>	<p>NEW</p>  <p>18-80404 FUEL CONNECTOR Fits: DF25-DF140 HP</p>	<p>NEW</p>  <p>18-80405 FUEL CONNECTOR Female to 3/8" hose barb. Use with 18-8078</p>										
 <p>18-8090 FUEL CONNECTOR (1/4" NPT)</p>	 <p>FUEL FILTERS</p> <table border="1"> <thead> <tr> <th>Sierra #</th> <th>Application:</th> </tr> </thead> <tbody> <tr> <td>18-7828</td> <td>1/4" Small Capacity (For 1/4" Fuel Line)</td> </tr> <tr> <td>18-7829</td> <td>1/4" Large Capacity (For 1/4" Fuel Line)</td> </tr> <tr> <td>18-7830</td> <td>5/16"</td> </tr> <tr> <td>18-7831</td> <td>3/8"</td> </tr> </tbody> </table>	Sierra #	Application:	18-7828	1/4" Small Capacity (For 1/4" Fuel Line)	18-7829	1/4" Large Capacity (For 1/4" Fuel Line)	18-7830	5/16"	18-7831	3/8"	 <p>18-7852-1 FUEL WATER SEPARATOR KIT Replaces: 99105-20001 Includes: 18-7845 Filter- 18-7853-1 Bracket 18-4256 1/4" (2) Brass Plug</p>
Sierra #	Application:											
18-7828	1/4" Small Capacity (For 1/4" Fuel Line)											
18-7829	1/4" Large Capacity (For 1/4" Fuel Line)											
18-7830	5/16"											
18-7831	3/8"											
<p>NEW</p>  <p>18-3000 IMPELLER Replaces: 17461-92D02 Fits: DT 8C/9.9C (1989-97)</p>	<p>NEW</p>  <p>18-3049 IMPELLER Replaces: 17461-87E11 Fits: DF 60/70 (1998-01), DF 90-100 (1989-01)</p>	 <p>18-3023 IMPELLER Replaces: 17461-90J00, 17461-94500, 17461-94501, 17461-94502, 17461-94503, 17461-94504, 17461-94505, 17461-94506, 17461-94510, 17461-94511, 17461-94520 2 Stroke DT115 (1981-01), DT140 (1981-01), DT150 (1986-01), DT200 (1986-00)</p>										

OUTBOARD









SUZUKI Cooling System



OUTBOARD

 <p>18-3092 IMPELLER Replaces: 17461-93001, 17461-93003</p>	 <p>18-3093 IMPELLER Replaces: 17461-93901, 17461-93902, 17461-83903</p>	 <p>18-3094 IMPELLER Replaces: 17461-94700</p>	 <p>18-3095 IMPELLER Replaces: 17461-95300, 17461-95301</p>																													
 <p>18-3096 IMPELLER Replaces: 17461-96301, 17461-96311</p>	 <p>18-3097 IMPELLER Replaces: 17461-98501, 17461-98502</p>	 <p>18-3099 IMPELLER Replaces: 17461-93902 For: DT 9.9, 15 (1983-97), DF 9.9, 15 (1997-05)</p>	<p>NEW</p>  <p>18-3291 IMPELLER KEY Replaces: 09420-05006 Fits: V-6 2-Stroke (1986-03), DF90/115/140(2001-04)</p>																													
<p>NEW</p>  <p>18-3292 IMPELLER KEY Replaces: 17462-93990 Fits: DT 8C/9.9C (1989-97), DF 9.9/15 (1997-04), DT 9.9 (1985-87), DT 15 (1983-88), DT 15C (1989-97)</p>	<p>NEW</p>  <p>18-3296 IMPELLER KEY Replaces: 09420-05005 Fits: DT 115/140 (1983-01)</p>	<p>NEW</p>  <p>18-3404 IMPELLER KEY Replaces: 09420-04009 Fits: DF 60/70 (1998-01), DF 90-100 (1989-01)</p>	<p>NEW</p>  <p>18-3188 IMPELLER PLATE Replaces: 17471-98503 Fits: DT 6 (1984-02), DT 8 (1986-97)</p>	<p>NEW</p>  <p>18-3189 IMPELLER PLATE Replaces: 17471-87D01 Fits: V-6 2-Stroke (1986-03)</p>																												
<p>NEW</p>  <p>18-3190 IMPELLER PLATE Replaces: 17471-93902 Fits: DF 9.9/15 (1997-04), DT 9.9 (1985-87), DT 15 (1983-88), DT 15C (1989-97)</p>	<p>NEW</p>  <p>18-3191 IMPELLER PLATE 17471-94501 Fits: DT 115/140 (1983-01)</p>	<p>NEW</p>  <p>18-3192 IMPELLER PLATE 17471-87E01 Fits: DF 60/70 (1998-01), DF 90-100 (1989-01), DF 90/115/140 (2001-04)</p>	<p>NEW</p>  <p>18-3193 IMPELLER PLATE 17471-92D10 Fits: DT 8C/9.9C (1989-97)</p>																													
<p>18-3242 IMPELLER REPAIR KIT Replaces: 17400-96350, 17400-96351</p> 		<p>18-3243 IMPELLER REPAIR KIT Replaces: 17400-94700</p> 																														
<p>— CONTAINS —</p> <table border="1"> <thead> <tr> <th>Sierra #</th> <th>Description</th> <th>O.E. #</th> </tr> </thead> <tbody> <tr> <td>18-3096</td> <td>Impeller</td> <td>17461-96311</td> </tr> <tr> <td>18-0461</td> <td>Gasket</td> <td>17472-96301</td> </tr> </tbody> </table>		Sierra #	Description	O.E. #	18-3096	Impeller	17461-96311	18-0461	Gasket	17472-96301	<p>— CONTAINS —</p> <table border="1"> <thead> <tr> <th>MODEL</th> <th>YEAR</th> <th>MODEL</th> <th>YEAR</th> </tr> </thead> <tbody> <tr> <td>DT20</td> <td>1986-88</td> <td>DT30C</td> <td>1988-95</td> </tr> <tr> <td>DT25</td> <td>1984-88</td> <td>DT35</td> <td>1987-89</td> </tr> <tr> <td>DT30</td> <td>1984-87</td> <td>DT40C</td> <td>1984-95</td> </tr> <tr> <td>DT25C</td> <td>1989-95</td> <td></td> <td></td> </tr> </tbody> </table>		MODEL	YEAR	MODEL	YEAR	DT20	1986-88	DT30C	1988-95	DT25	1984-88	DT35	1987-89	DT30	1984-87	DT40C	1984-95	DT25C	1989-95		
Sierra #	Description	O.E. #																														
18-3096	Impeller	17461-96311																														
18-0461	Gasket	17472-96301																														
MODEL	YEAR	MODEL	YEAR																													
DT20	1986-88	DT30C	1988-95																													
DT25	1984-88	DT35	1987-89																													
DT30	1984-87	DT40C	1984-95																													
DT25C	1989-95																															
<table border="1"> <thead> <tr> <th>Sierra #</th> <th>Description</th> <th>O.E. #</th> </tr> </thead> <tbody> <tr> <td>18-3094</td> <td>Impeller</td> <td>17461-94700</td> </tr> <tr> <td>18-0460</td> <td>Gasket</td> <td>17472-95310</td> </tr> </tbody> </table>		Sierra #	Description	O.E. #	18-3094	Impeller	17461-94700	18-0460	Gasket	17472-95310	<table border="1"> <thead> <tr> <th>MODEL</th> <th>YEAR</th> <th>MODEL</th> <th>YEAR</th> </tr> </thead> <tbody> <tr> <td>DT55</td> <td>1985-95</td> <td>DT65</td> <td>1985-95</td> </tr> </tbody> </table>		MODEL	YEAR	MODEL	YEAR	DT55	1985-95	DT65	1985-95												
Sierra #	Description	O.E. #																														
18-3094	Impeller	17461-94700																														
18-0460	Gasket	17472-95310																														
MODEL	YEAR	MODEL	YEAR																													
DT55	1985-95	DT65	1985-95																													

IMPELLER APPLICATION ON NEXT PAGE





 <p>18-3244 IMPELLER REPAIR KIT Replaces: 17400-95550</p> <p>— CONTAINS —</p> <table border="1"> <thead> <tr> <th>Sierra #</th> <th>Description</th> <th>O.E. #</th> <th>MODEL</th> <th>YEAR</th> <th>MODEL</th> <th>YEAR</th> </tr> </thead> <tbody> <tr> <td>18-3095</td> <td>Impeller</td> <td>17461-95300</td> <td>DT75</td> <td>1985-95</td> <td>DT85</td> <td>1985-95</td> </tr> <tr> <td>18-0459</td> <td>Gasket</td> <td>17472-95200</td> <td></td> <td></td> <td></td> <td></td> </tr> </tbody> </table>	Sierra #	Description	O.E. #	MODEL	YEAR	MODEL	YEAR	18-3095	Impeller	17461-95300	DT75	1985-95	DT85	1985-95	18-0459	Gasket	17472-95200					 <p>18-3253 WATER PUMP KIT Replaces: 17400-87D11 Fits: V6 2-Stroke (1986-03)</p>
Sierra #	Description	O.E. #	MODEL	YEAR	MODEL	YEAR																
18-3095	Impeller	17461-95300	DT75	1985-95	DT85	1985-95																
18-0459	Gasket	17472-95200																				
 <p>18-3254 WATER PUMP KIT Replaces: 17400-87E03 Fits: DF 60/70 (1998-01), DT 90-100 (1989-01)</p>	 <p>18-3255 WATER PUMP KIT Replaces: 17400-92D01 Fits: DT 8C/9.9C (1989-97)</p>																					
 <p>18-3256 WATER PUMP KIT Replaces: 17400-93951 Fits: DF 9.9/15 (1997-04), DT 9.9 (1985-87), DT 15 (1983-88), DT 15C (1989-97)</p>	 <p>18-3257 WATER PUMP KIT Replaces: 17400-94611 Fits: DT 115/140 (1983-01)</p>																					
 <p>18-3258 WATER PUMP KIT Replaces: 17400-90J11 Fits: DF 90/115/140 (2001-04)</p>	 <p>18-3259 WATER PUMP KIT Replace: 17400-98551 Fits: DT 6 (1984-02), DT8 (1986-97)</p>	 <p>18-3260 WATER PUMP KIT Replaces: 17400-98652, 17400-98661 Fits: DT 4 (1984-98), DT 5 (1999-02)</p>																				





OUTBOARD

SUZUKI

Cooling System/Internal Engine



 <p>18-0458 WATER PUMP GASKET Replaces: 17472-94510</p>	 <p>18-0459 WATER PUMP GASKET Replaces: 17472-95200</p>	 <p>18-0460 WATER PUMP GASKET Replaces: 17472-95310</p>	 <p>18-0461 WATER PUMP GASKET Replaces: 17472-96301</p>
--	--	--	--

















 <p>18-0477-9^① WATER PUMP GASKET Replaces: 17472-98503 Fits: DT 6 (1984-02), DT8 (1986-97)</p>	 <p>18-0478 WATER PUMP GASKET Replaces: 17472-93911 Fits: DF 9.9/15 (1997-04), DT 9.9 (1985-87), DT 15 (1983-88), DT 15C (1989-97)</p>	 <p>18-0479 WATER PUMP GASKET Replaces: 17472-92D10 Fits: DT 8C/9.9C (89-97)</p>	 <p>18-0480 WATER PUMP GASKET Replaces: 17472-98611 Fits: DT 4 (1984-98), DT 5 (1999-02)</p>
--	---	---	---

HP/Model	Year	Sierra Impeller	Sierra Gasket	HP/Model	Year	Sierra Impeller	Sierra Gasket
DT4	1984-98	18-3097	18-0480	DT35	1980-82	18-3094	18-0459
DT5	1977-83	18-3097	—	DT35	1987-89	18-3096	18-0461
DT6	1984-02	18-3097	18-0477-9	DT40	1980-83	18-3094	18-0459
DT8	1980-87	18-3097	18-0477-9	DT40/DT40C	1984-98	18-3096	18-0461
DT8	1988-97	18-3000	18-0479	PU40 (jet)	1989-94	18-3096	18-0461
DT9.9	1977-82	18-3092	—	DT50	1982-prior	18-3094	18-0459
DT9.9	1983-87	18-3093	18-0478	DT50	1983	18-3094	18-0460
DT9.9	1988-97	18-3000	18-0479	DT50	1984	18-3095	18-0460
DF9.9/15	1996-04	18-3093	18-0478	DT50M	1980-84	18-3094	18-0460
DT14	1977-80	18-3092	—	DT55	1985-97	18-3094	18-0460
DT15	1983-Up	18-3093	18-0478	PU55 (jet)	1989-94	18-3094	18-0460
DT15C	1989-97	18-3093	18-0478	DT60	1983	18-3094	18-0460
DF15	1997-98	18-3093	18-0478	DT60	1984	18-3096	18-0460
DT16	1977-82	18-3092	—	DT65	1982-prior	18-3094	18-0459
DT20	1986-88	18-3096	18-0461	DT65	1985-97	18-3096	18-0460
DT25	1980-82	18-3092	—	DT75	1983-97	18-3095	18-0459
DT25	1983-88	18-3096	18-0461	DT85	1980-97	18-3095	18-0459
DT30	1983-87	18-3096	18-0461	PU85 (jet)	1989-97	18-3095	18-0459

	O.E. INTERCHANGE		
	Sierra #	Description	O.E. #
	18-39480	Piston Rings	12140-93121
	18-39480	Ring Set	12140-93121
	18-39530	Piston Rings	12140-96351-050
	18-39530	Ring Set	12140-96351-050
	18-39540	Piston Rings	12140-94400
	18-39540	Ring Set	12140-94400
	18-40110	Piston Kit	12110-94400
	18-40140	Piston Kit	12110-93120
18-40190	Piston Kit	12100-96353-050	
18-42850	Piston Pin	12151-94400	
18-42860	Wrist Pin	12151-93100	
18-42870	Wrist Pin	12151-92502	
18-42940-9	Circlips	09381-14001	
18-42950-9	Circlips	09381-18002	
18-42960-9	Circlips	09381-20003	

HP/Model	Years	PISTON		RINGS		WRIST PIN		CIRCLIP	
		Std.	.50mm	Std.	.50mm	Std.	.50mm	Std.	.50mm
DT9.9	1983-87	18-40140	—	18-39480	—	18-42860	—	18-42940-9	—
DT15	1983-88	18-40140	—	18-39480	—	18-42860	—	18-42940-9	—
DT25	1983-88	—	18-40190	—	18-39530	—	18-42870	—	18-42950-9
DT30	1983-87	—	18-40190	—	18-39530	—	18-42870	—	18-42950-9
DT40	1984-98	18-40110	—	18-39540	—	18-42850	—	18-42960-9	—

① Priced per Package

<p>NEW</p>  <p>18-1757 CONNECTING ROD Replaces: 12161-93902 Fits: DT9.9, DT15 (1983-97)</p>	<p>NEW</p>  <p>18-1758 CONNECTING ROD Replaces: 12161-96300 Fits: DT25 (1983-88), DT30 (1983-87)</p>	<p>NEW</p>  <p>18-1759 CONNECTING ROD Replaces: 12161-94400 Fits: DT 40 (1984-98)</p>	
<p>NEW</p>  <p>18-1757K CONNECTING ROD KIT Replaces: 12161-93902 Fits: DT9.9 (1983-87), DT15 (1983-97)</p>	<p>NEW</p>  <p>18-1759K CONNECTING ROD KIT Replaces: 12161-94400 Fits: DT40 (1986-98)</p>	<p>NEW</p>  <p>18-1412 ROD BEARING Replaces: 09263-20051 Fits: DT9.9 (1983-87), DT15 (1983-97)</p>	
<p>NEW</p>  <p>18-1414 ROD BEARING Replaces: 09263-14022 Fits: DT9.9 (1983-87), DT15 (1983-97), DT14/16 (1980-82)</p>	<p>NEW</p>  <p>18-1415 ROD BEARING Replaces: 09263-18016 Fits: DT25 (1983-88), DT30 (1983-87)</p>	<p>NEW</p>  <p>18-1416 ROD BEARING Replaces: 09263-27005 Fits: 40 (1984-98)</p>	
<p>NEW</p>  <p>18-1417 WRIST PIN BEARING Replaces: 09263-20072 Fits: 40 (1984-98)</p>	 <p>18-3806 HEAD GASKET Replaces: 11141-98401</p>	 <p>18-3807 HEAD GASKET Replaces: 11141-98101</p>	 <p>18-3808 HEAD GASKET Replaces: 11141-93901</p>
 <p>18-3809 HEAD GASKET Replaces: 11141-96303</p>	 <p>18-3810 HEAD GASKET Replaces: 11141-94401</p>	 <p>18-3811 HEAD GASKET Replaces: 11141-94303</p>	 <p>18-3813 HEAD GASKET Replaces: 11141-95305</p>





OUTBOARD



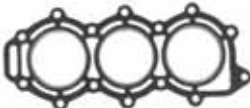

SUZUKI

Internal Engine



 18-3814 HEAD GASKET Replaces: 11141-95505	 18-3816 HEAD GASKET Replaces: 11141-98504, 11141-98522	 18-3817 HEAD GASKET Replaces: 11141-92D01
--	---	---

 18-3819 HEAD GASKET Replaces: 11141-95D90	 18-3820 HEAD GASKET Replaces: 11141-94701, 11141-94702	 18-3821 HEAD GASKET Replaces: 11141-95600	 18-3822 HEAD GASKET Replaces: 11141-87E90
--	---	---	--

 18-3823 HEAD GASKET Replaces: 11141-94506	 18-3824 HEAD GASKET Replaces: 11141-94600	 18-3825 HEAD GASKET Replaces: 11141-87D90	 18-3826 HEAD GASKET Replaces: 11141-87D92
--	--	--	--

Model	Year	Cyl	Head Gasket	Model	Year	Cyl	Head Gasket	Model	Year	Cyl	Head Gasket
2	1983-89	1	18-3806	30	1988-89	3	18-3819	90	1989	V-4	18-3822
5	1983	2	18-3816	35	1987-89	2	18-3810	100	1989	V-4	18-3822
6	1984-89	2	18-3807	40	1983	2	18-3811	115	1983-85	4	18-3823
8	1983-87	2	18-3807	40	1984-89	2	18-3810	115	1986-89	4	18-3824
8	1988-89	2	18-3817	50	1984	2	18-3813	140	1983-85	4	18-3823
9.9	1983-87	2	18-3808	55	1985-89	3	18-3820	140	1986-89	4	18-3824
9.9	1988-89	2	18-3817	65	1985-89	3	18-3820	150	1986	V-6	18-3825
15	1983-89	2	18-3808	75	1983-87	3	18-3814	150	1987-89	V-6	18-3826
25	1983-88	2	18-3809	75	1988-89	3	18-3821	175	1987-89	V-6	18-3826
25	1989	3	18-3819	85	1983-87	3	18-3814	200	1986	V-6	18-3825
30	1983-87	2	18-3809	85	1988-89	3	18-3821	200	1987-89	V-6	18-3826

 18-7895 OIL FILTER Replaces: 16510-93J00 Fits:DF 200/225/250	 18-7896 OIL FILTER Replaces: 16510-61A20-MHL Fits:DF90/115	 18-7897 OIL FILTER Replaces: 16510-82703 Fits:DF140
--	--	---

OUTBOARD



SUZUKI

Internal Engine/Drive System

 <p>18-7903 OIL FILTER Replaces: 16510-05240 FOR: DF9.9, DF15</p>	 <p>18-7915 OIL FILTER Replaces: 16510-87J00, For: DF25, DF30, DF40, DF50, DF60, DF70 4-stroke</p>	 <p>18-8331 18-8331-9^① DRAIN PLUG GASKET Replaces: 09168-10022</p>	 <p>18-8334 SHIFT SHAFT SEAL Replaces: 25223-94400</p>																																									
 <p>18-3726 PROP NUT Replaces: 09141-18005</p>	 <p>18-3710 PROP NUT Replaces: 09141-14008</p>	 <p>PROP SPACER</p> <table border="1"> <thead> <tr> <th>Model</th> <th>Sierra #</th> <th>O.E. #</th> </tr> </thead> <tbody> <tr> <td>V-6</td> <td>18-3795</td> <td>57633-87D30</td> </tr> <tr> <td>DT75/85/90/100/115/140 w. V style/ DF60/70 w. V style</td> <td>18-3798</td> <td>57633-94500</td> </tr> <tr> <td>DT20/25C/30C</td> <td>18-3799</td> <td>57630-96300</td> </tr> </tbody> </table>	Model	Sierra #	O.E. #	V-6	18-3795	57633-87D30	DT75/85/90/100/115/140 w. V style/ DF60/70 w. V style	18-3798	57633-94500	DT20/25C/30C	18-3799	57630-96300	 <p>18-3774 PROP NUT KIT Replaces: 57630-94500 For: DT75/85/90/100/115, 140 with V-Style, DF60/70 with V Style — CONTAINS —</p> <table border="1"> <thead> <tr> <th>Sierra #</th> <th>O.E. #</th> <th>Desc.</th> </tr> </thead> <tbody> <tr> <td>18-3726</td> <td>09141-18005</td> <td>Prop Nut</td> </tr> <tr> <td>18-3735</td> <td>09204-03003, 09204-03004</td> <td>Cotter Pin</td> </tr> <tr> <td>—</td> <td>09160-18028</td> <td>Washer</td> </tr> <tr> <td>18-3798</td> <td>57633-94500</td> <td>Spacer</td> </tr> </tbody> </table>	Sierra #	O.E. #	Desc.	18-3726	09141-18005	Prop Nut	18-3735	09204-03003, 09204-03004	Cotter Pin	—	09160-18028	Washer	18-3798	57633-94500	Spacer														
Model	Sierra #	O.E. #																																										
V-6	18-3795	57633-87D30																																										
DT75/85/90/100/115/140 w. V style/ DF60/70 w. V style	18-3798	57633-94500																																										
DT20/25C/30C	18-3799	57630-96300																																										
Sierra #	O.E. #	Desc.																																										
18-3726	09141-18005	Prop Nut																																										
18-3735	09204-03003, 09204-03004	Cotter Pin																																										
—	09160-18028	Washer																																										
18-3798	57633-94500	Spacer																																										
 <p>18-3775 PROP NUT KIT Replaces: 57630-92E00 For: V-6 — CONTAINS —</p> <table border="1"> <thead> <tr> <th>Sierra#</th> <th>O.E.#</th> <th>Description</th> </tr> </thead> <tbody> <tr> <td>18-3726</td> <td>09141-18005</td> <td>Prop Nut</td> </tr> <tr> <td>18-3735</td> <td>09204-03003, 09204-03004</td> <td>Cotter Pin</td> </tr> <tr> <td>—</td> <td>09160-18019</td> <td>Washer</td> </tr> <tr> <td>18-3795</td> <td>57633-87D30</td> <td>Spacer</td> </tr> </tbody> </table>	Sierra#	O.E.#	Description	18-3726	09141-18005	Prop Nut	18-3735	09204-03003, 09204-03004	Cotter Pin	—	09160-18019	Washer	18-3795	57633-87D30	Spacer	 <p>18-3777 PROP NUT KIT Replaces: 57630-94300 For: DT40/55/65 — CONTAINS —</p> <table border="1"> <thead> <tr> <th>Sierra#</th> <th>O.E.#</th> <th>Description</th> </tr> </thead> <tbody> <tr> <td>18-3726</td> <td>09141-18005</td> <td>Prop Nut</td> </tr> <tr> <td>18-3735</td> <td>09204-03003, 09204-03004</td> <td>Cotter Pin</td> </tr> <tr> <td>—</td> <td>09160-18028</td> <td>Washer</td> </tr> </tbody> </table>	Sierra#	O.E.#	Description	18-3726	09141-18005	Prop Nut	18-3735	09204-03003, 09204-03004	Cotter Pin	—	09160-18028	Washer	 <p>18-3778 PROP NUT KIT Replaces: 57630-96300 For: DT20/25C/30C — CONTAINS —</p> <table border="1"> <thead> <tr> <th>Sierra#</th> <th>O.E.#</th> <th>Description</th> </tr> </thead> <tbody> <tr> <td>18-3735</td> <td>09204-03003, 09204-03004</td> <td>Cotter Pin</td> </tr> <tr> <td>—</td> <td>09160-14028</td> <td>Washer</td> </tr> <tr> <td>18-3710</td> <td>09141-14008</td> <td>Prop Nut</td> </tr> <tr> <td>18-3799</td> <td>57633-96300</td> <td>Spacer</td> </tr> </tbody> </table>	Sierra#	O.E.#	Description	18-3735	09204-03003, 09204-03004	Cotter Pin	—	09160-14028	Washer	18-3710	09141-14008	Prop Nut	18-3799	57633-96300	Spacer
Sierra#	O.E.#	Description																																										
18-3726	09141-18005	Prop Nut																																										
18-3735	09204-03003, 09204-03004	Cotter Pin																																										
—	09160-18019	Washer																																										
18-3795	57633-87D30	Spacer																																										
Sierra#	O.E.#	Description																																										
18-3726	09141-18005	Prop Nut																																										
18-3735	09204-03003, 09204-03004	Cotter Pin																																										
—	09160-18028	Washer																																										
Sierra#	O.E.#	Description																																										
18-3735	09204-03003, 09204-03004	Cotter Pin																																										
—	09160-14028	Washer																																										
18-3710	09141-14008	Prop Nut																																										
18-3799	57633-96300	Spacer																																										
 <p>③ 18-6032 ANODE Replaces: 55320-95310 55-140 H.P.</p>	 <p>③ 18-6033 ANODE Replaces: 55125-87D00 150-200 H.P.</p>	 <p>③ 18-6098 ANODE Replaces: 55125-96310 DF25, DF30, DT20, DT25, DT25C, DT30, DT30C, DT35</p>	<p>PKG. OF 10</p>  <p>COTTER PINS</p> <table border="1"> <thead> <tr> <th>Sierra #</th> <th>Replaces</th> </tr> </thead> <tbody> <tr> <td>18-3737^②</td> <td>29204-09204</td> </tr> <tr> <td></td> <td>For: DT9.9 & 15C, DF9.9 & 15, 8 & 9.9C (Oil Injected)</td> </tr> <tr> <td>18-3735^②</td> <td>09204-03003, 09204-03004</td> </tr> </tbody> </table> <p>For: DT20, 25C, 30C</p>	Sierra #	Replaces	18-3737 ^②	29204-09204		For: DT9.9 & 15C, DF9.9 & 15, 8 & 9.9C (Oil Injected)	18-3735 ^②	09204-03003, 09204-03004																																	
Sierra #	Replaces																																											
18-3737 ^②	29204-09204																																											
	For: DT9.9 & 15C, DF9.9 & 15, 8 & 9.9C (Oil Injected)																																											
18-3735 ^②	09204-03003, 09204-03004																																											

OUTBOARD

① Priced per Package
② This product is priced per piece. To order priced per package, please add -9 to the part number
③ Zinc

SUZUKI

Seal Kits



OUTBOARD

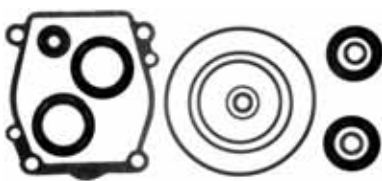

**18-8335
LOWER UNIT SEAL KIT**
Replaces: 25700-87D00

— CONTAINS —

Sierra#	Description	O.E.#	Qty.
18-7118	O-Ring	09280-08008	1
18-7183	O-Ring	09280-69001	2
18-7422	O-Ring	09280-20004	1
18-8331	Drain Plug Gasket	09168-10022	2



**18-8336
LOWER UNIT SEAL KIT**
Replaces: 25700-87E00

— CONTAINS —

Sierra#	Description	O.E.#	Qty.
18-7118	O-Ring	09280-08008	1
18-7127	O-Ring	09280-86001	1
18-7183	O-Ring	09280-69001	1
18-7422	O-Ring	09280-20004	1
18-8320	Seal	09282-22004	2
18-8331	Drain Plug Gasket	09168-10022	3



**18-8337
LOWER UNIT SEAL KIT**
Replaces: 25700-94400

— CONTAINS —

Sierra#	Description	O.E.#	Qty.
18-0461	Water Pump Gasket	17472-96301	1
18-7151	O-Ring	09280-75001	1
18-7413	O-Ring	09280-08005	2
18-8331	Drain Plug Gasket	09168-10022	3
18-8334	Shift Shaft Seal	25223-94400	1
18-8345	Seal	09289-22007	2

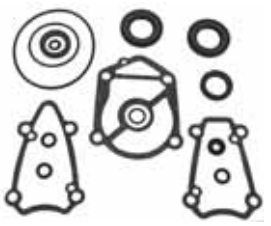

**18-8338
LOWER UNIT SEAL KIT**
Replaces: 25700-94500

— CONTAINS —

Sierra#	Description	O.E.#	Qty.
18-0268	O-Ring	09280-55002	1
18-0458	Water Pump Gasket	17472-94510	1
18-7118	O-Ring	09280-08008	1
18-7191	O-Ring	09280-15003	1
18-8321	Seal	09282-24003	2
18-8323	Seal	09282-28002	2
18-8331	Drain Plug Gasket	09168-10022	3

— CONTAINS —

Sierra#	Description	O.E.#	Qty.
18-0460	Water Pump Gasket	17472-95310	1
18-7151	O-Ring	09280-76006	1
18-7413	O-Ring	09280-08005	1
18-8329	Seal	09289-17005	1
18-8331	Drain Plug Gasket	09168-10022	3
18-8334	Shift Shaft Seal	25223-94400	1
18-8343	Seal Ring	55122-95201	1
18-8345	Seal	09289-22007	2



**18-8339
LOWER UNIT SEAL KIT**
Replaces: 25700-94700

— CONTAINS —

Sierra#	Description	O.E.#	Qty.
18-0459	Water Pump Gasket	17472-95200	1
18-7506	O-Ring	09280-85001	1
18-8323	Seal	09282-28002	2
18-8331	Drain Plug Gasket	09168-10022	3
18-8334	Shift Shaft Seal	25223-94400	1



**18-8340
LOWER UNIT SEAL KIT**
Replaces: 25700-95500

SEAL KIT APPLICATION ON NEXT PAGE

— CONTAINS —

Sierra#	Description	O.E. #	Qty.
18-0461	Water Pump Gasket	17472-96301	1
18-7118	O-Ring	09280-50005	1
18-7413	O-Ring	09280-08005	1
18-7140	O-Ring	09282-17006	1
18-8317	Seal	09282-17007	2
18-8330	Seal	09289-20009	2
18-8331	Drain Plug Gasket	09168-10022	3

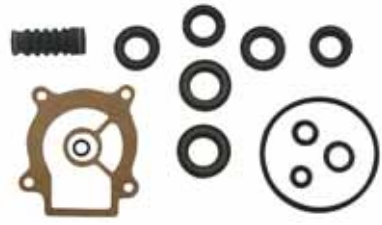

18-8341
LOWER UNIT SEAL KIT
Replaces: 25700-95D00

NEW



18-8373
LOWER UNIT SEAL KIT
Replaces: 25700-90J01
Fits: DF 90/115 (All Years)

NEW



18-8374
LOWER UNIT SEAL KIT
Replaces: 25700-92J00
Fits: DF140 (All Years)

SEAL KIT APPLICATION

HP/Model	Year	Sierra#	HP/Model	Year	Sierra#	HP/Model	Year	Sierra#
DF90/115	All	18-8373	DT40C	1984-98	18-8337	DT85	1985-98	18-8340
DF140	All	18-8374	DT55	1985-97	18-8339	DT90	1989-97	18-8336
DT25C	1989-98	18-8341	DT65	1985-97	18-8339	DT100	1989-98	18-8336
DT30C	1988-97	18-8341	DT75	1985-97	18-8340			

PKG. OF 2



OIL SEALS

Part#	O.E. #	I.D.	Dimensions O.D. (mm)	Width
* 18-0544	09282-24004	23.2	40.3	7
* 18-0545	09289-10002	9	22.2	8
* 18-0546	09282-30007	29.5	50.25	6
* 18-0551	09283-10011	9	22.2	8
18-8316	09282-17006	17	30	4.5
18-8317	09282-17007	17	28	6
18-8320	09282-22004	22	36	6
18-8321	09282-24003	25	36	6
18-8323	09282-28002	28	50	6
18-8329	09289-17005	15.85	35.1	9
18-8330	09289-20009	19.447	34	6.5
18-8345	09289-22007	22.2	35	5

PKG. OF 5

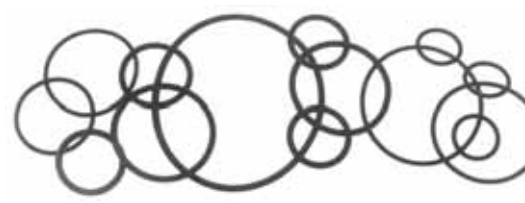

O-RINGS

Part No.	O.E. No.	I.D.	Dimensions I.D. (mm)	Width
18-7118 ①	09280-08008	69.40	69.40	3.10
18-7140 ①	09280-75002	69.00	69.00	3.50

* New Product

① This product is priced per piece. To order priced per package, please add -9 to the part number

OUTBOARD